

**Demo Case**

**Ordering Code: DEMO.C-NEBULA-3TS-DP.V1**

**Size: 300mm x 300mm x 85mm**

**Weight: ~2000g**

# NEBULA TREE SPIKE DAPPLE

SIZE-3 OUTDOOR SERIES

Crafted with meticulous attention to detail, the Nebula Tree Spike Dapple Demo Case replicates nature's delicate play of light and shadow through our innovative B-Module. Its modular design, featuring interchangeable LED engines for effortless customization and maintenance, integrates seamlessly with Bluetooth and the DALI Touch app for intuitive control. This versatile system efficiently powers multiple luminaires with a single LED driver on a constant voltage platform, illuminating both indoor and outdoor spaces with captivating light and shadow effects that enrich landscapes with natural beauty and serenity.



## Compatible LED Module



## Fixture Features



IP66 IK08

## Driver Dimming Variation



(DA)



## B-Module

### Illuminate with the Magic of Dappled Light



#### Dappled Light Aesthetics

Captivatingly mimicking nature's play of light and shadow, an immersive visual experience unfolds.

100K  
HOURS

#### Extended Operating Lifetime

Solid-state electronics for longevity.



#### Plug & Play Simplicity

Seamless 'plug & play' simplicity: no controls, just effortless installation.



2200K 4500K

#### Eco-sensitive Spectrum

Tailor your lighting for a natural ambiance, customizing from warm to cool tones.



#### Modular Scalability

Modular design for ultimate flexibility: multiple possibilities for indoor and outdoor applications.



#### Illuminating Eco-Conscious Harmony

Nature-inspired lighting design sparks awareness while fostering a symbiotic relationship with nature.

# Dynamic Movement

Dynamic Movement explores the mesmerizing interplay of light and shadow within dapple lighting. It transforms static environments into visually captivating spaces, with shifting shadows and dynamic energy. This concept adds depth, intrigue, and vitality to the scene, immersing viewers in an ever-evolving visual experience. Dynamic Movement celebrates the transformative power of dapple lighting, inviting viewers to engage with the dynamic interplay of light and shadow, and unlocking a world of captivating moments.

When powered on, the B-Module initiates dynamic movement autonomously. Through the DALI Control Interface, dynamic movement can be dimmed and adjusted across a spectrum of mood tones and dapple movement speeds.

## Light Theme

### Dapple - 4 modes

The B-Module's light theme draws inspiration from the serene hues of nature, specifically reflecting the soft, gentle glow of moonlight. Mimicking the natural color palette observed during different phases of the moon, it captures the ethereal essence of lunar light, fostering a deeper connection to the tranquil beauty of the night sky.



Cool  
Graphite

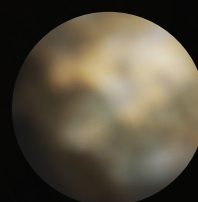

Warm  
Graphite

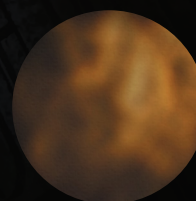

Golden



Silver



# ENHANCING ENVIRONMENTS WITH 24CV LIGHTING SOLUTIONS

A variant of LED modules and luminaires that operates with 24V DC constant voltage, allowing multiple luminaires to be driven by a single LED driver.

Equipped with built-in ATePS technology, the LED lifetime is guaranteed and protected against abnormally high ambient temperature conditions.

## B-Module Options



35 PLE BM Dapple

Lumen Output up to 610lm

Input Power 8W



35 PRO BM Dapple

Lumen Output up to 610lm

Input Power 8W

## Types of configuration for 24CV B-Modules

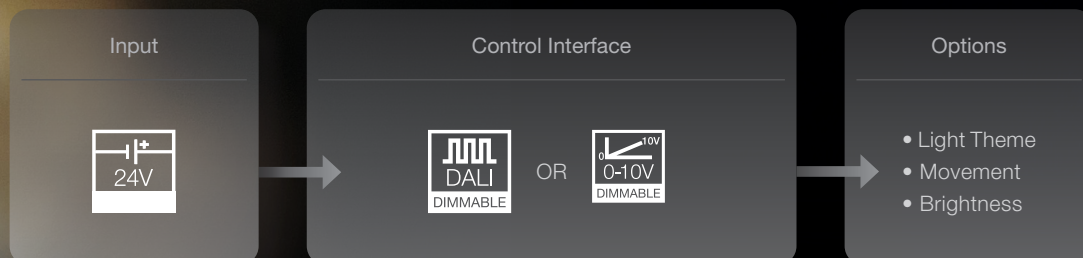

# NEBULA TREE SPIKE DAPPLE DEMO CASE

 **IP 66 IK08**



DEMO CASE INCLUSIVE OF:

1



AC 220-240V Plug

Choose Plug:

TYPE G



UK

TYPE C



EU

TYPE I



CN / AU

TYPE B





US

2



Wireless Configurator

3

Downlight Fixture Dapple Nebula Treespoke						BM LED Module									
Type	Ingress Protection		Colour		Snoot		Input Power		Beam Angle		Light Theme		Interface		
 <p><b>NEBULA-3TS-DP</b></p>	<b>IP66</b>	IP66	<b>GR</b>	Matt Grey	<b>FS</b>	Full Snoot	 <p><b>ELR35PLE-BM</b></p>	<b>8W</b>	<b>20</b> <b>35</b> <b>60</b>	20° 35° 60°	<b>D4</b>	Dapple - 4 Modes		<b>DA</b>	DALI

CONNECTION DIAGRAM

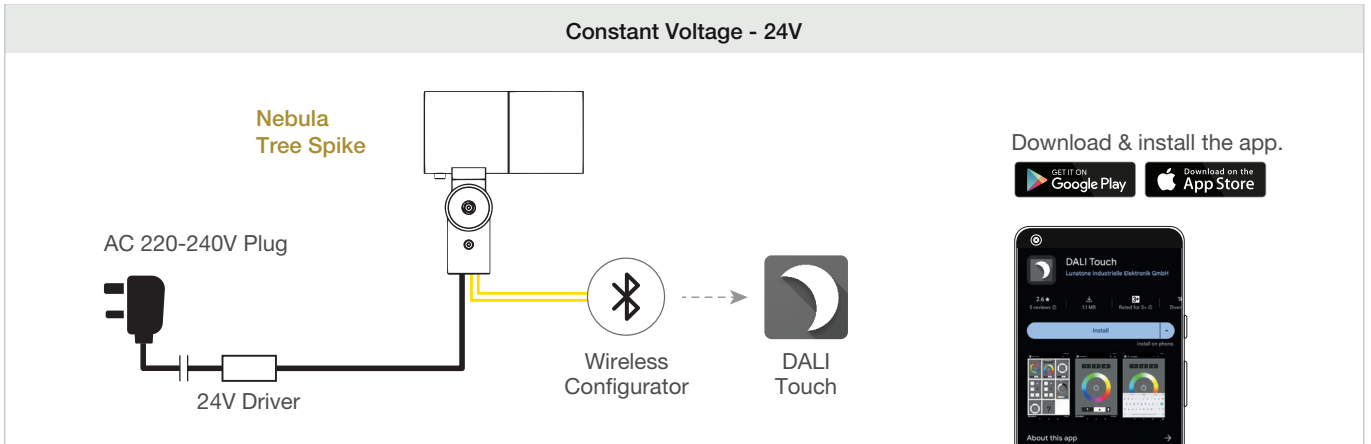

Steps to install B-Module Dapple

**Step 1:**  
Launch the app and select "Manage Themes"

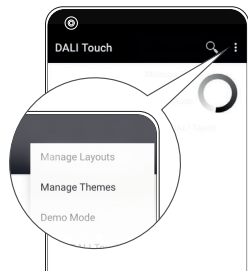

**Step 2:**  
Log in with Account Name: **Dapple** Theme password: **1234**

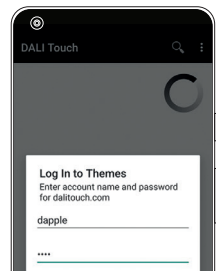

**Step 3:**  
Install Dapple Setup and return to the previous page

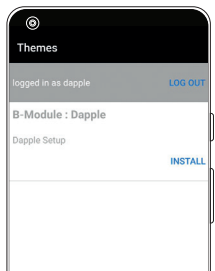

**Step 4:**  
Tap the icon to launch

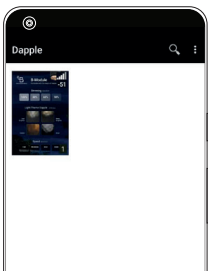

**Step 5:**  
Begin experimenting with Dapple effects

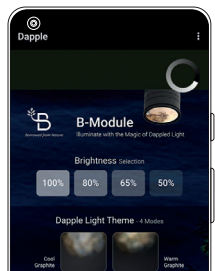

B-Module Command

**Dapple Light Theme - 4 Modes:**





DALI Command "Goto Scene 0"  
Cool Graphite

DALI Command "Goto Scene 1"  
Warm Graphite

DALI Command "Goto Scene 2"  
Golden

DALI Command "Goto Scene 3"  
Silver



**Brightness Selection:**

- Direct Arc Power Command (0-254)
- Up and Down Command
- OFF and Recall Max Level

**Movement Selection:**

- Store the DTR as Fade Time Command
- Value range (0 until 15 level)
- 0 level – Fastest
- 15 level – Very slow (~30 second a movement / frame)